

DWG. NO.

SIMILAR ITEM

PROJECT NO.

C

B

DO NOT SCALE DRAWING
DIMENSION IN METRIC

8 7 6 5 4 3 2 1

F

E

D

C

B

A

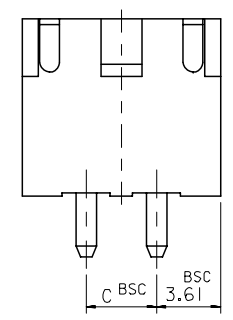
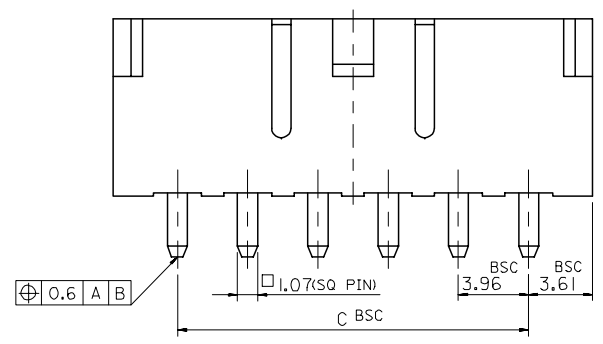
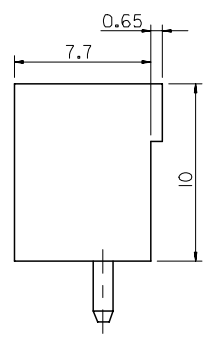
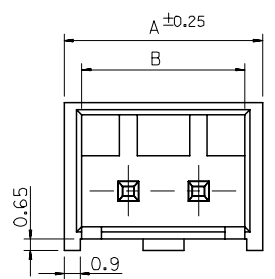
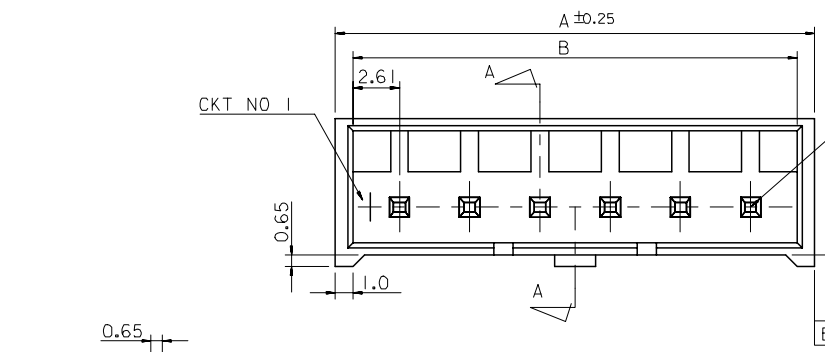

2 CKT ONLY

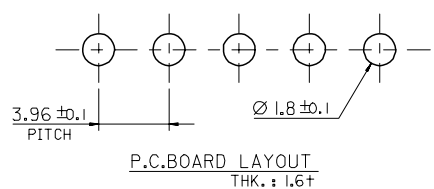
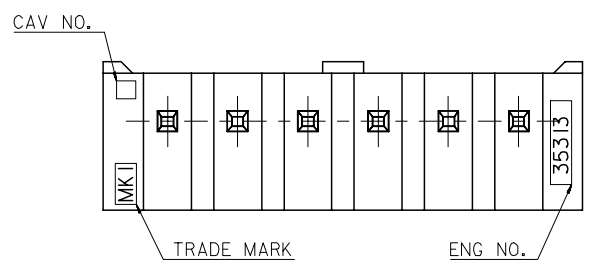

NOTE
I. MATERIAL : WAFER : NYLON66, GLASS FILLED 20% UL94V-0
PIN : BRASS, TIN PLATED

LEGEND
35313-** I *
COLOR : 0 - NATURAL
1 - BLACK
2 - RED
3 - YELLOW
4 - BLUE
CKT NO.(02,03,04...)

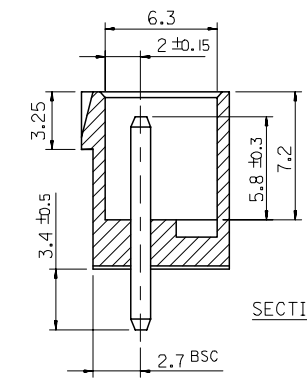

43.56	48.78	50.78	35313-121*	12
39.6	44.82	46.82	-111*	11
35.64	40.86	42.86	-101*	10
31.68	36.9	38.9	-091*	9
27.72	32.94	34.94	-081*	8
23.76	28.98	30.98	-071*	7
19.8	25.02	27.02	-061*	6
15.84	21.06	23.06	-051*	5
11.88	17.1	19.1	-041*	4
7.92	13.14	15.14	-031*	3
3.96	9.18	11.18	35313-021*	2
C	B	A	ENG NO.	CKT NO.

REVISED ECN NO. KOR2006-0105 DRWN: K.S.KIM 060323 CHK: K.S.KIM APPR: Y.SOO.KIM	DESCRIPTION MAJOR CRITICAL C	GENERAL TOLERANCES: (UNLESS SPECIFIED)		SCALE 3.5-1	DESIGN UNITS <input checked="" type="checkbox"/> MM <input type="checkbox"/> INCH	THIRD ANGLE PROJECTION <input type="checkbox"/> 1ST ANGLE <input checked="" type="checkbox"/> 3RD ANGLE	DIMENSIONS: <input type="checkbox"/> MM <input type="checkbox"/> INCH <input checked="" type="checkbox"/> MM ONLY	SHT REV		
		4 PLACES ±0. ±-	3 PLACES ±0. ±-	2 PLACES ±0. ±-	1 PLACE ±0.2 ±-	DRAWN BY & DATE H.S.SHIN (930128)	TITLE: 3.96 PITCH W/B CONN. WAFER ASS'Y (WITH LOCK)			REVISE ON CAD ONLY
		ANGULAR: ± 2 °		APPROVED BY & DATE C.W.LEE	CAD FILENAME	MOLEX INCORPORATED			SHEET NO. 1 OF 1	
		DRAFT WHERE APPLICABLE MUST REMAIN WITHIN DIMENSIONS		THIS DRAWING CONTAINS INFORMATION THAT IS PROPRIETARY TO MOLEX INCORPORATED AND SHOULD NOT BE USED WITHOUT WRITTEN PERMISSION.			MATERIAL NO. DRAWING NO. SD 35313-** I *		SIZE B	

8 7 6 5 4 3 2 1 KOREA MX-A3